

ORDINANCE NO 97-8

AN ORDINANCE OF THE TOWNSHIP OF HOPEWELL
AMENDING AND REPLACING CHAPTER 133
"STREETS AND SIDEWALKS,"
ARTICLE I "STREET OPENINGS AND EXCAVATIONS"
PROVIDING REGULATIONS AND PROCEDURES FOR
THE OPENING OR EXCAVATION OF A
TOWNSHIP STREET OR RIGHT-OF-WAY

Chapter 133

STREETS AND SIDEWALKS

ARTICLE I
STREET OPENINGS AND EXCAVATIONS

- § 133-1. Title, purpose, validity, definitions and word usage.
- § 133-2. Permit required.
- § 133-3. Requirements for permit issuance.
- § 133-4. Separate permits required.
- § 133-5. Calculation of deposit.
- § 133-6. Regulations.
- § 133-7. Return of deposit.
- § 133-8. Inspections.
- § 133-9. Violations and penalties.
- § 133-10. Fee schedule.
- § 133-11. Standard restoration details.
- § 133-12. Repealer

[**HISTORY:** Adopted by the Board of Commissioners of the Township of Hopewell: Art. I, 6-22-79 as Ord. No. 79-3. Sections 133-9 and 133-11 amended at time of adoption of Code; see Ch. 1, General Provisions, Art. I. Other amendments noted where applicable.]

WHEREAS, the Board of Commissioners of the Township of Hopewell, pursuant to the terms and provisions of the Pennsylvania First Class Township Code, maintains certain roadways and right-of-ways within the Township, and

WHEREAS, pursuant to the authority granted unto it by the said State Legislature, desires to mandate certain regulations relative to the opening or excavation of said roadways and right-of-ways, and

WHEREAS, the Township of Hopewell, in the within Ordinance and in the regulations referred to herein, is referred to as "Hopewell Township".

NOW THEREFORE, WITNESSETH AS FOLLOWS:

ARTICLE I
Street Openings and Excavations

- § 133-1. Title, purpose, validity, definitions and word usage
- A. This Ordinance shall be known as the "Hopewell Township Street Opening Ordinance."
 - B. The purpose of this Ordinance is to provide minimum standards to safeguard persons, to protect property, maintain the present level of ecology, and promote the public safety and welfare by regulating and controlling the opening or excavation of roadways and right-of-ways within the Township of Hopewell.
 - C. If any Section, subsection, sentence, clause, or phrase of this Ordinance is for any reason held to be invalid or unconstitutional by the decision of any court of competent jurisdiction, such decision shall not affect the validity of the remaining portions of this Ordinance.
 - D. The following words, when used in this Article shall have the meanings ascribed to them in this section, except in those instances where the context clearly indicates otherwise.

APPLICANT - Any person as defined in this section who makes application for a permit.

EMERGENCY - Any condition constituting a clear and present danger to life or property by reason of escaping gas, exposed wires or other similar or serious breaks or defects in an underground line.

PERMITTEE - Any person, as defined in this section, who has been issued a permit and has agreed to fulfill the terms of this Article.

PERSON - Includes any natural person, partnership, firm, association, utility, authority or corporation.

STREET - Any public right-of-way, street, avenue, road, square, alley, highway or other public place located in the Township of Hopewell and established for the use of vehicles.

- E. In this Article, the singular shall include the plural, and the masculine shall include the feminine and the neuter.

§ 133-2. Permit required

It shall be unlawful, except in cases of emergency, for any person to make any opening or excavation of any kind in or under any street without first securing a permit from the Township for each separate undertaking. Any person making application for a permit shall agree to the terms of this Article as hereinafter provided. Minor excavations not within the paved or otherwise improved portion of any street and not greater than one (1) foot in depth made for the purposes of installing, maintaining, or replacing a driveway, sidewalk, mailbox, or other similar appurtenance which may be authorized or permitted under other Ordinances of Hopewell Township, shall be exempt.

§ 133-3. Requirements for permit issuance

It shall be the duty of the applicant to comply with the following express conditions and provisions before a permit shall be granted:

- A. A written application on the official form provided for this purpose by the Township shall be filed for each and every opening and be signed by the responsible person authorized to do so.

- B. The applicant shall set forth the purpose of such opening, exact location of such opening, and size and depth of such opening.
- C. The applicant shall establish the date or dates during which such opening is to be permitted, including the date and time when temporary and/or final resurfacing is to be performed.
- D. The applicant shall take out and maintain public liability and property damage insurance in an amount sufficient to indemnify and save harmless the Township of Hopewell from all liability for damages or injury done to persons and property which may be incurred by reason of such opening or any failure to properly protect, maintain, barricade, light, backfill and/or otherwise properly effect the same. The insurance shall not be in an amount less than one million dollars (\$1,000,000.00) for injury to persons and one hundred thousand dollars (\$100,000.00) for injury to property. The township shall set the amount of insurance in accordance with the size of the opening. The applicant shall name Hopewell Township as an additional insured and provide proof of said insurance to the Township.
- E. The applicant shall deliver to the township a deposit or bond in the amount set by the township. This amount shall be calculated according to § 133-5 of this Article. It shall never be less than five hundred dollars (\$500.00).
- F. Whenever any public utility or municipal authority maintaining underground facilities shall contemplate more than one (1) street opening or excavation per calendar year, it may post a bond to cover all work in an amount calculated according to Section 6 of this Ordinance. The insurance requirements of Subsection D shall be waived upon receipt of notice of self-insurance by any public utility or municipal authority. In any case, the bond shall be approved by the Board of Commissioners.

§ 133-4. Separate permits required

The applicant shall secure a permit for each and every street opening. In cases of emergency, the Police Department shall be notified, and a permit shall be secured on the first official workday thereafter.

§ 133-5. Calculation of deposit

The Township, upon receipt of the properly completed application shall compute the amount of deposit or bond to be deposited by the applicant with the Township of Hopewell to reimburse said Township for any cost of work and materials furnished for the backfilling or refilling of the opening or excavation and the restoring of the surface or replacing the pavement over any such opening or excavation, together with any expenditure for labor, material and/or inspection subsequently necessitated in the maintenance, repairing or resurfacing of any such opening in the street for a period of one (1) year from date of completion so as to leave any such street in as good a condition as it was before such excavation or opening. The amount calculated for deposit or bond shall include the estimated cost of inspection and any other cost that may be directly charged to the opening or excavation of the street. The total amount calculated shall be increased by twenty-five percent (25%) to determine the amount of deposit or bond.

§ 133-6. Regulations

- A. The permittee shall take every necessary and reasonable precaution to keep the street in a safe and passable condition at all times by providing and maintaining any necessary guards, barricades, lights, signs, or other such devices in accordance with PennDOT Publication 203 - Work Zone Traffic Control, latest revision.
- B. No opening in any street shall extend beyond the center line of the street before being refilled and the surface of the street restored to a condition safe and convenient for travel by vehicles or pedestrians.
- C. No more than one hundred (100) feet measured longitudinally shall be opened in any street at any one (1) time.
- D. No tunnelling shall be allowed without express approval of the Township and permission therefor endorsed on the permit.
- E. Excavated or other material shall be placed or stored on the side of the operation farthest from the pavement, unless otherwise designated by the Township and in such

manner that there will be no interference with the flow of water and/or traffic.

- F. Where a pipe drain, pipe culvert or other structure or facility is encountered, it shall be replaced, restored, strengthened or protected by the permittee.
- G. All openings and excavations shall be backfilled promptly with suitable materials and thoroughly compacted in layers according to Township specifications and as the Township Engineer shall direct.
- H. Temporary surfacing, consisting of not less than two (2) inches of bituminous cold patch material, shall be installed in all excavations within the paved portion of any street as soon as possible following the completion of the backfilling procedure. In no case shall the placement of bituminous cold patch material be delayed more than one (1) business day following the completion of the backfilling procedure.

Temporary surfacing shall be maintained for a period of at least two (2) weeks free of depressions and mounds. After that length of time, and as soon as conditions permit, the temporary surfacing shall be removed and immediately replaced with the final surfacing. The final surfacing shall be completed in the presence of the Hopewell Township Engineer and in accordance with the applicable Standard Restoration Details or as otherwise directed by the Hopewell Township Engineer or other authorized agent of Hopewell Township.

- I. All restored surfaces must be at least twelve (12) inches wider on each side than the excavated trench and shall be restored in strict accordance with the applicable Standard Restoration Details and/or specifications and directions of the Township Engineer.
- J. In no case shall any opening or excavation made by a permittee be considered in the charge or care of the Township or of any officer or person employed by the Township and no officer or employee of the Township is authorized in any way to take or assume any responsibility over any such opening or excavation, except in the exercise of police power where and when it is necessary to protect life and property.
- K. The permittee shall provide and maintain all necessary shoring and/or bracing of openings so as to protect

persons, roadways, utilities, and adjacent land and buildings from damage resulting from shifting or subsidence of the adjacent land.

- L. No refilling of such excavation or opening shall be accomplished unless or until the Hopewell Township Engineer or other authorized agent of Hopewell Township shall be present.
- M. Hopewell Township shall provide notice to all persons owning property abutting on any street within Hopewell Township about to be paved or otherwise improved, and to all public utility companies and municipal authorities operating within Hopewell Township, and all such persons, public utility companies, and municipal authorities shall make all connections and any repairs thereto which would necessitate excavation of the street within thirty (30) days from the giving of such notice, unless such time is extended in writing by Hopewell Township. The repair and restoration of any street which has been paved or otherwise improved within five (5) years of opening or excavation shall be made in strict accordance with the applicable Standard Restoration Details and/or specifications and directions of the Hopewell Township Engineer.

§ 133-7. Return of deposit

After one (1) year, the permanent restoration of the opened or excavated street shall be inspected by the Township or other authorized employee of the Township who, if restoration shall be satisfactory and up to the Township specification, shall certify that such work is accepted by the Township. Upon certification of acceptance of the work, the permittee shall be refunded his deposit less all costs incurred by the Township.

§ 133-8. Inspections

The Township Engineer or any other authorized employee of the Township shall have the right to observe and inspect all work done under a street opening permit and shall see that all terms and conditions of this Article are enforced and shall have the power and is hereby directed to prosecute every person violating any of the provisions contained herein. Such supervision and inspection shall

be done at the sole expense of the permittee and shall be paid in full within thirty (30) days of invoice.

§ 133-9. Violations and penalties

Any person violating any of the provisions of this Article shall, upon conviction thereof before the District Justice, pay the full cost of street restoration and pay a fine of not more than six hundred dollars (\$600.00) plus costs of prosecution and, in default thereof of payment of such fine and costs of prosecution, shall be imprisoned for not more than thirty (30) days. Each day such violation is committed or permitted to continue shall constitute a separate offense and shall be punishable as such hereunder.

§ 133-10. Fee Schedule

The fee schedule for street opening permits shall be established by the Board of Commissioners and adopted by resolution of the Board and payment of said fee is a requirement for issuance of any permit.

§ 133-11. Standard restoration details

The standard restoration details as prepared by the Township Engineer are on file in the Township offices and said details shall be complied with by all persons.

§ 133-12. Repealer

All Ordinances and parts of Ordinances inconsistent herewith are hereby repealed.

ORDAINED and enacted into law by the Board of

Commissioners of the Township of Hopewell on the 14 day of October, 1997.

ATTEST:

Patricia J. Gandy
Manager

TOWNSHIP OF HOPEWELL

Betsy A. D'Amico, Jr.
President, Board of Commissioners

(APPLICABLE ONLY TO ROADS NOT RESURFACED
IN THE LAST FIVE (5) YEARS.)

SEAL WITH AC-20,
6" WIDTH ON ALL
SIDES.

SEAL JOINTS IN ACCORDANCE WITH PENNDOT
SECT. 401.3(j)3, 6" BOTH SIDES OF JOINT
WITH E-6 OR E-8 EMULSIFIED ASPHALT OR
HOT BITUMINOUS MATERIAL.

EXIST. BITUMINOUS
SURFACE

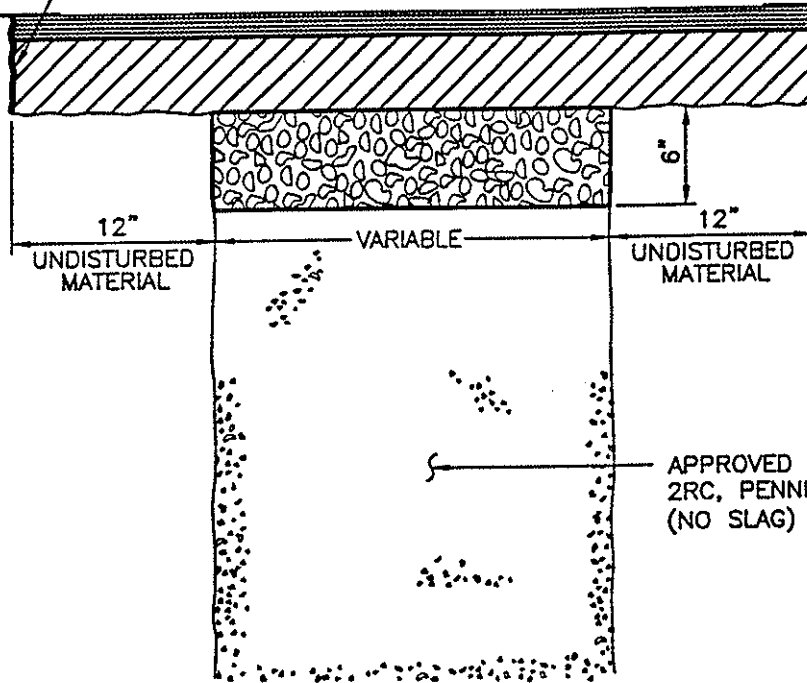

SAWCUT EDGES,
PAINT JOINT WITH THIN
COAT OF E-6 OR E-8
EMULSIFIED ASPHALT.

APPROVED EXCAVATED MATERIAL OR
2RC, PENNDOT SECT. 703.3 AS DIRECTED
(NO SLAG)

NOTE:

1. ALL BACKFILL SHALL BE COMPACTED IN 6" LAYERS,
MECHANICALLY TAMPED.
2. TEMPORARY BITUMINOUS COLD PATCH SHALL BE USED IN ALL
AREAS WHERE EXISTING FLEXIBLE-BASE PAVEMENT HAS BEEN
REMOVED.

 1 1/2" ID-2 BITUMINOUS WEARING COURSE,
PENNDOT SECT. 420

 5" BITUMINOUS CONCRETE BASE COURSE,
PENNDOT SECT. 305

 6" No. 2A SUBBASE,
PENNDOT SECT. 350

STANDARD TRENCH DETAIL
AND PAVEMENT REPLACEMENT FOR
BITUMINOUS PARKING AREAS, DRIVEWAYS,
BERMS, AND TOWNSHIP ROADS

NIRA Consulting Engineers, Inc.

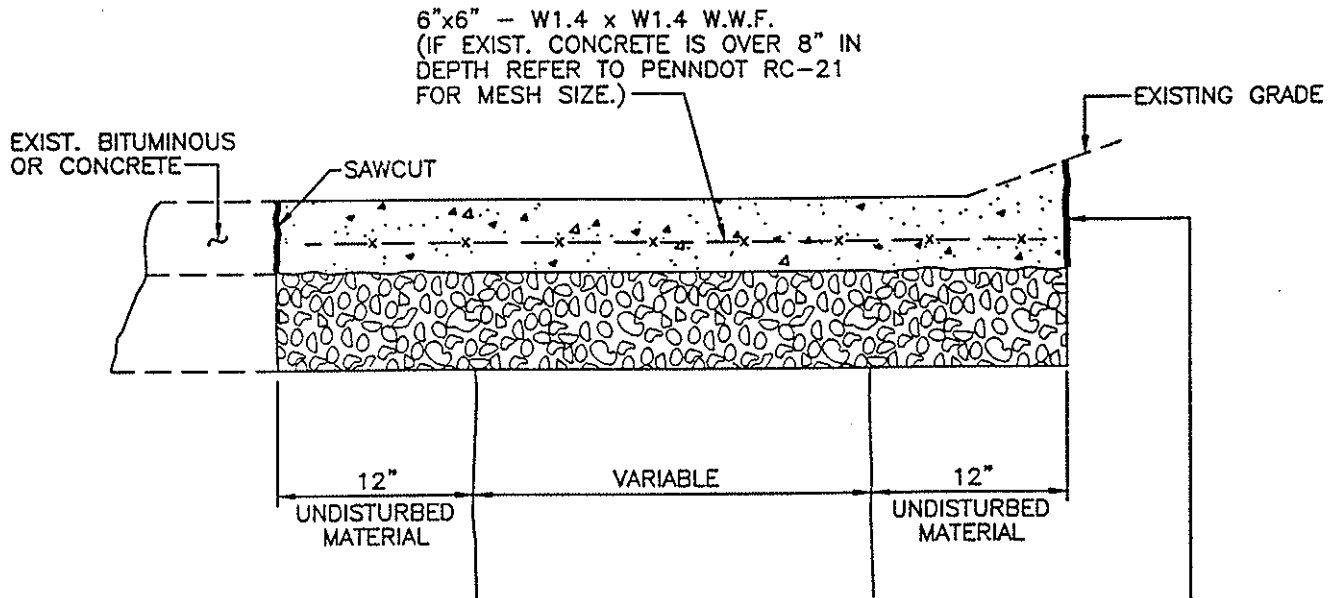

SAWCUT AND FORM TO MATCH EXISTING CONCRETE SHOULDER OR DRIVEWAY. USE 1/2" PREMOLDED EXPANSION JOINT FILLER WHERE CONCRETE BUTTS TO CONCRETE. WHERE CONCRETE BUTTS TO ASPHALT, PAINT ASPHALT JOINT WITH A THIN COAT OF E-6 OR E-8 EMULSIFIED ASPHALT.

NOTE:

TEMPORARY BITUMINOUS COLD PATCH SHALL BE USED IN ALL AREAS WHERE EXISTING RIGID-BASE PAVEMENT HAS BEEN REMOVED.



CLASS AA CEMENT CONCRETE,
DEPTH TO MATCH EXISTING.



6" No. 2A COARSE AGGREGATE,
PENNDOT SECT. 350

CONCRETE PAVEMENT,
CONCRETE SHOULDER, AND
DRIVEWAY RESTORATION DETAIL

NIRA Consulting Engineers, Inc.

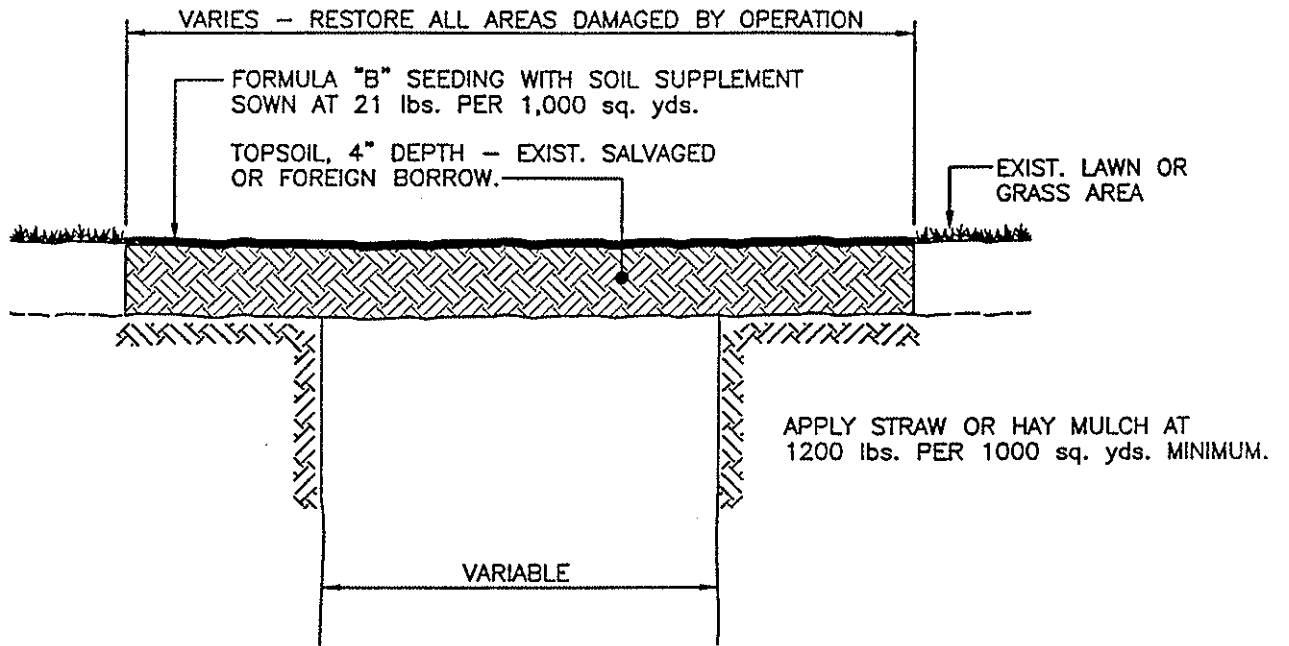

LAWN AND GRASS AREA
RESTORATION DETAIL

NIRA Consulting Engineers, Inc.

EXISTING
SLAG DRIVEWAY

TYPE 'A' No. 57 COARSE AGGREGATE
PENNDOT SECT. 703.2 (NO SLAG)
OR LIMESTONE CHIPS TO MATCH EXIST.,
CHOKE AND ROLL, 4" MIN. DEPTH.

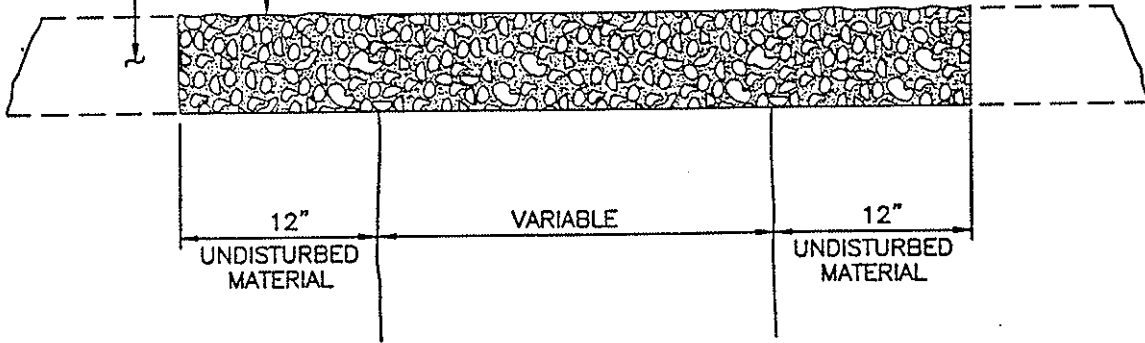

SLAG DRIVEWAY
RESTORATION DETAIL

NIRA Consulting Engineers, Inc.

(APPLICABLE ONLY TO ROADS RESURFACED IN THE LAST FIVE (5) YEARS.)

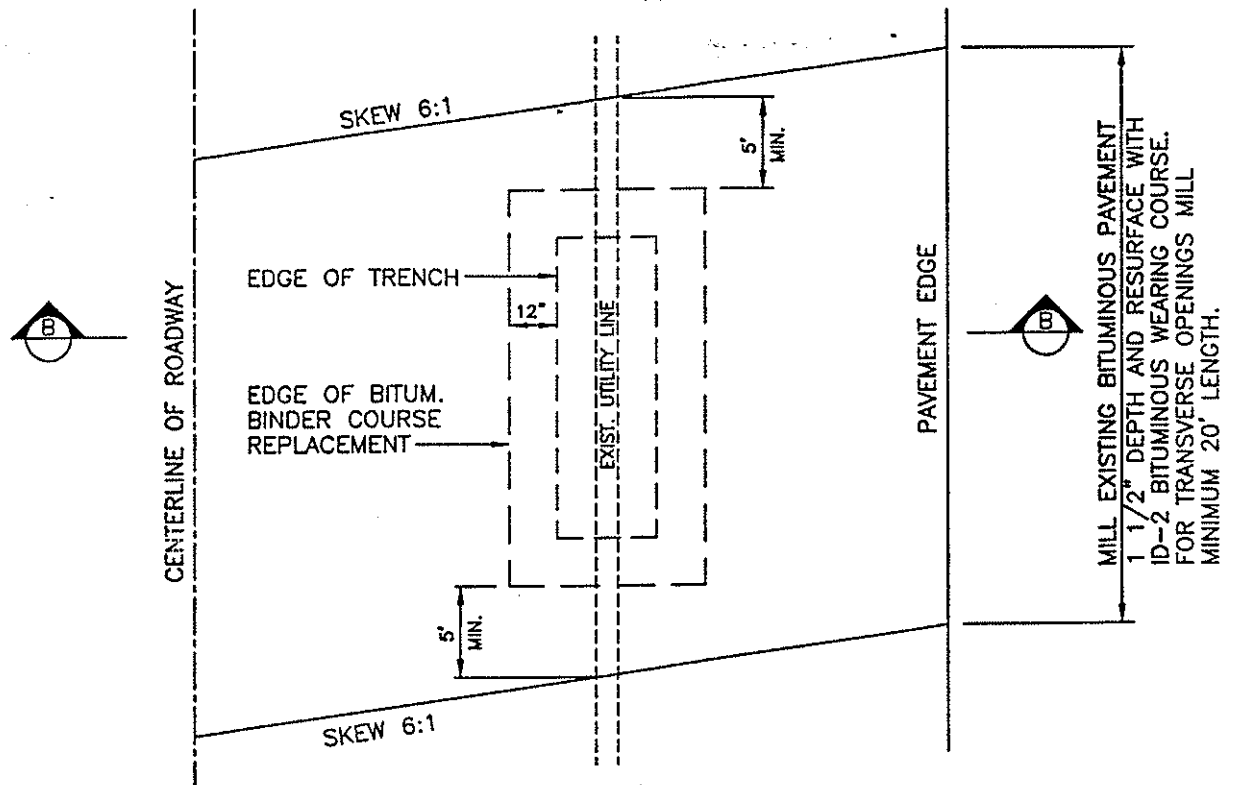

PLAN - PAVEMENT RESTORATION DETAIL 'B'

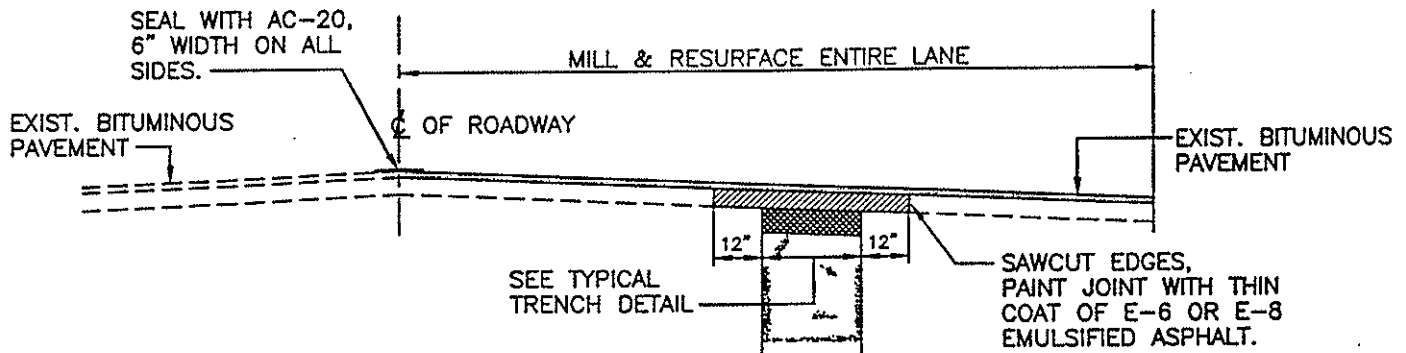



SECTION B-B

NOTE:

1. 2" MINIMUM BITUMINOUS COLD PATCH (TEMPORARY SURFACE) REQUIRED IN TRENCH AREA PRIOR TO FINAL SURFACING.
2. IF UTILITY OPENING EXTENDS INTO OR INVOLVES BOTH LANES THE ENTIRE CARTWAY SHALL BE MILLED AND RESURFACED.
3. THE MINIMUM LENGTH OF THE MILLED AND RESURFACED AREA SHALL BE 20 FEET.

 1 1/2" ID-2 BITUMINOUS WEARING COURSE, PENNDOT SECT. 420

 5" BITUMINOUS CONCRETE BASE COURSE, PENNDOT SECT. 305

 6" No. 2A SUBBASE, PENNDOT SECT. 350

STANDARD BITUMINOUS
PAVEMENT REPLACEMENT DETAIL

NIRA Consulting Engineers, Inc.

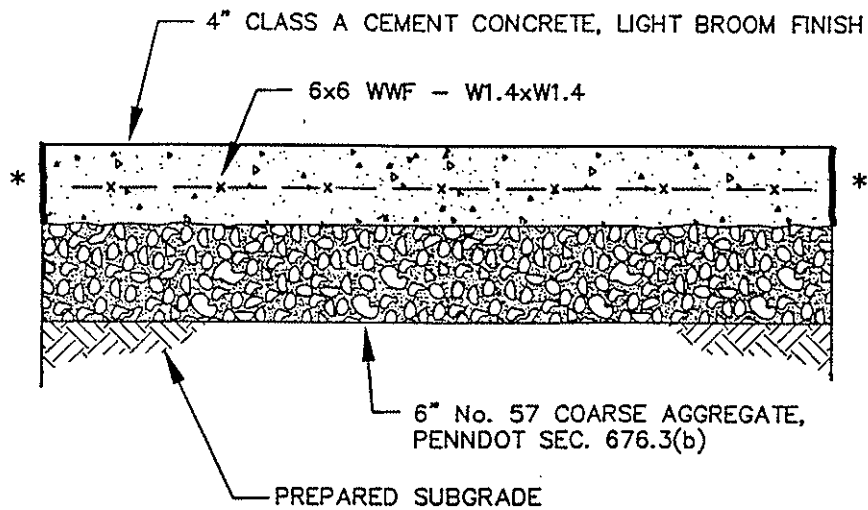

NOTES:

1. FORM OUTSIDE EDGES AND JOINTS WITH 1/4" RADIUS EDGING TOOL.
2. FORM TRANSVERSE DUMMY JOINTS @ 5 FOOT INTERVALS, APPROX. 1/8" WIDE AND AT LEAST 1 INCH DEEP.
- *3. WHEN BUTTING INTO EXISTING BITUMINOUS, SAWCUT BITUMINOUS AND PAINT BITUMINOUS WITH A THIN COAT OF E-6 OR E-8 EMULSIFIED ASPHALT.
- *4. WHEN BUTTING INTO EXISTING CONCRETE, SAWCUT CONCRETE AND USE 1/2" PREMOLDED EXPANSION FILLER FULL DEPTH OF SIDEWALK.

TYPICAL CONCRETE SIDEWALK
REPLACEMENT DETAIL

NIRA Consulting Engineers, Inc.